



# RAINWATCH FILTER

---

## INSTALLATION & MAINTENANCE GUIDE

---

- WHAT'S INCLUDED IN THE RAINWATCH PACK
  - FITTING THE FILTER
  - INSTALLING THE FIRST FLUSH DEVICE
  - CLEANING (REMOVING THE CANISTER)
- 

**DOUST**

DOUST PLUMBING PRODUCTS

The RainWatch filter is manufactured from the highest quality materials and is UV resistant.

However, it is prudent to protect the RainWatch filter from direct sunlight.

# INCLUDED IN THIS BOX

## 1 X RAINWATCH® FILTER (ASSEMBLED) EXPLODED VIEW

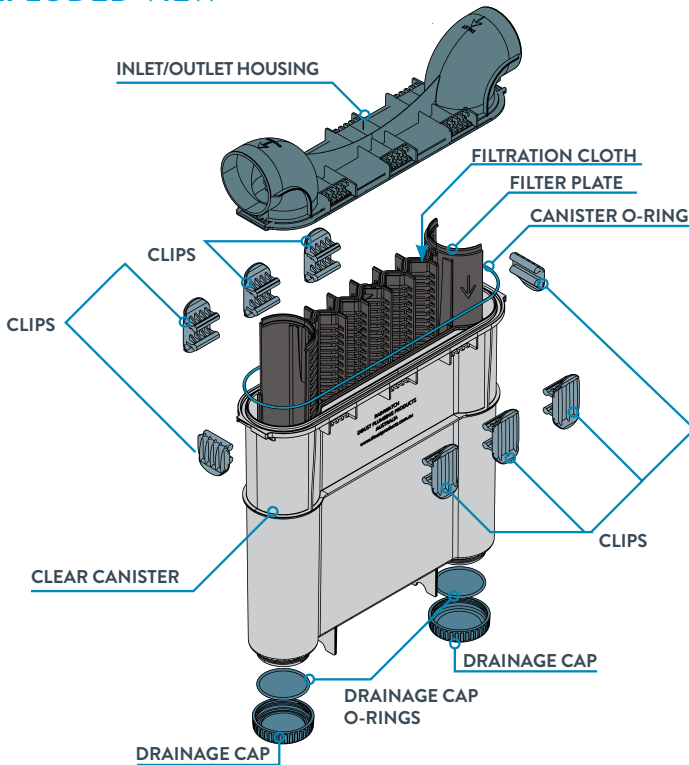

FIRST FLUSH DEVICE INCLUDED  
SEE PAGE 4 FOR INSTALLATION INSTRUCTIONS



6 X MASONRY PLUGS  
TO SUITE ¼ INCH OR 6.35MM DRILL



6 X SCREWS



1 X HANGER BRACKET  
(TOP)



1 X BASE BRACKET  
(BOTTOM)



1 X FIRST FLUSH DEVICE

## TOOLS REQUIRED FOR FITTING

- NOT INCLUDED -



HACKSAW



DRILL

+ SUITABLE  
DRILL BITS

6.35 mm Bit  
3 - 4 mm Bit



A SCREWDRIVER



SPIRIT LEVEL



PROBABLY A  
LIGHT HAMMER

## ATTENTION BEFORE INSTALLATION

Adequately Size your RainWatch Filters.

You should provide **one RainWatch Filter** for **every outlet** in your gutter or with an Annual Rainfall of:

### Annual Rainfall

300 mm = One RainWatch Filter per 100/200 m<sup>2</sup> of Roof

400 mm = One RainWatch Filter per 50/100 m<sup>2</sup> of Roof

400 mm Plus = One RainWatch Filter no greater than 25m<sup>2</sup> of Roof

# FITTING THE RAINWATCH FILTER

PLEASE READ ALL INSTRUCTIONS CAREFULLY BEFORE INSTALLING.

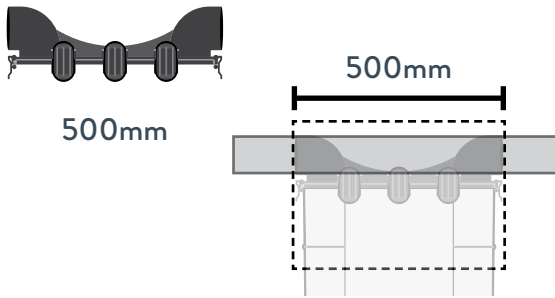

## 1. FITTING LOCATION

- The RainWatch filter will require a length of 500 mm on the horizontal plane, as the inlet/outlet housing on the filter (the black top section) is 500 mm long

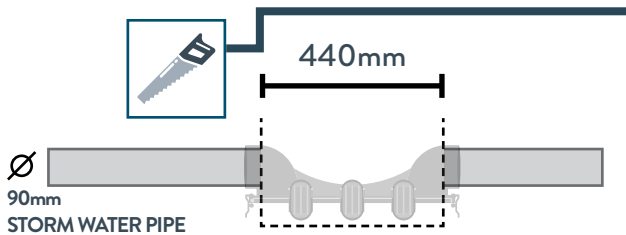

## 2. CUTTING THE STORM WATER PIPE

- Allowing for two 30 mm joints
- RainWatch requires a level 440 mm cut out area (with a 90 mm storm water line)

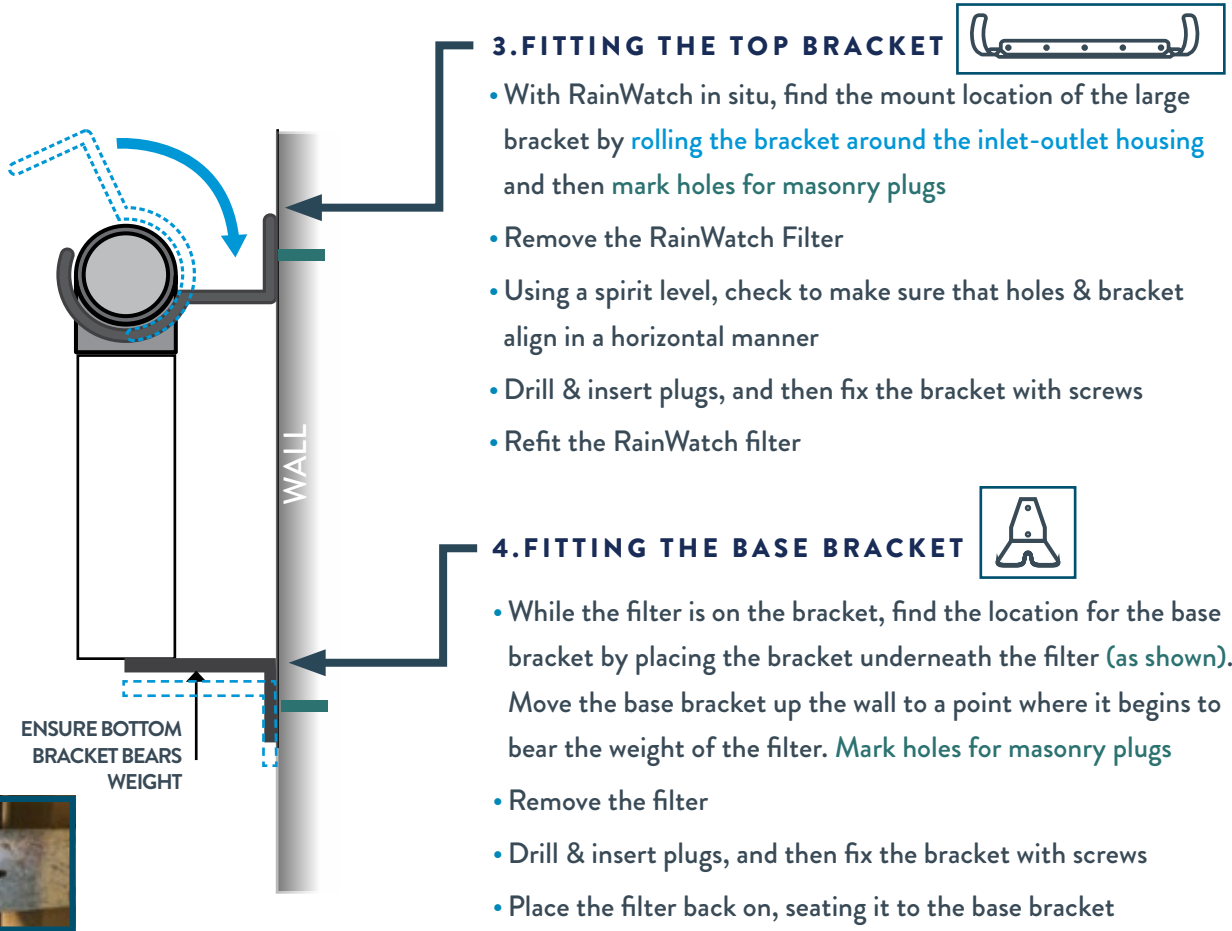

## 3. FITTING THE TOP BRACKET

- With RainWatch in situ, find the mount location of the large bracket by rolling the bracket around the inlet-outlet housing and then mark holes for masonry plugs
- Remove the RainWatch Filter
- Using a spirit level, check to make sure that holes & bracket align in a horizontal manner
- Drill & insert plugs, and then fix the bracket with screws
- Refit the RainWatch filter

## 4. FITTING THE BASE BRACKET

- While the filter is on the bracket, find the location for the base bracket by placing the bracket underneath the filter (as shown). Move the base bracket up the wall to a point where it begins to bear the weight of the filter. Mark holes for masonry plugs
- Remove the filter
- Drill & insert plugs, and then fix the bracket with screws
- Place the filter back on, seating it to the base bracket

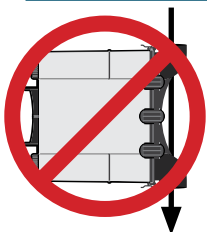

**DO NOT** fit the RainWatch Filter on to a vertical pipe



**DO NOT** Glue the filter to the 90 mm storm water line. This will impair the ability to clean the RainWatch Filter.

# | FIRST FLUSH DEVICE |

THE RAINWATCH FILTER IS DESIGNED TO ALLOW A FIRST FLUSH CLEAN BY REMOVING THE CAP AT THE BOTTOM OF THE INLET.

The device allows the RainWatch filter to remain dry by the use of a drainage drip outlet.

The device should be fitted using the drainage cap on the outlet end of the filter (where the water travels from the filter toward the rainwater tank).

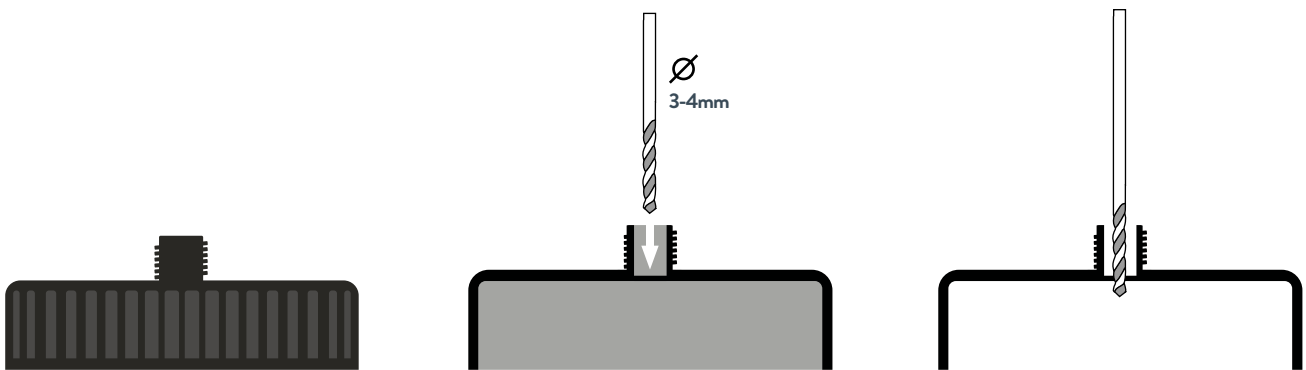

Unscrew the cleaning cap by hand, place the cap on a flat surface and carefully drill a 3-4mm hole as shown

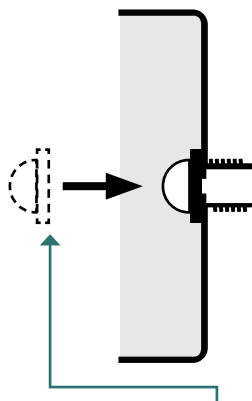

Place the hose filter on the underside of the cap.

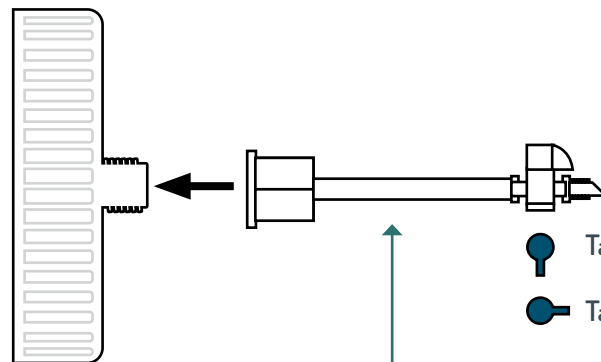

Screw on the drip feed fitting. and place the cap back on the filter.

**PLEASE NOTE** it is normal for the tap to drip in the turned off position.

**Please note:** Provide a 150 mm relief over flow above the Rainwatch filter and have a minimum relief of 150 mm from the bottom of the gutter for a continual discharge making sure that no water can enter the building.

# | REMOVING THE FILTER CANISTER & CLEANING THE RAINWATCH FILTER |



## 1 | REMOVING CLIPS

Clips can be lifted and removed by hand. There is no hinge, so they are able to be removed from the fitting completely.

(SEE 9 FOR CLIP REPLACEMENT)

## 2 | REMOVING FILTER PLATE

The filter plate can be lifted from the canister, by gently levering it with two screwdrivers placed on the lugs of the filter plate.

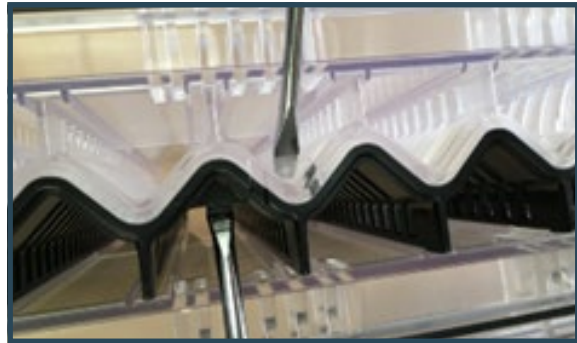

## 3 | CLEANING

Thoroughly clean the canister with cold water.

Clean 316 Stainless Steel filter with a soft brush by washing and hosing down.

And if required, additionally wash with a soft bush both sides of the 316 stainless steel surface mesh with a mild detergent in warm water. Finally, rinse in clean cold water.

## 4 | FILTER REPLACEMENT 4/4

To ensure the filter plate is snug place the filter canister upside down and lightly tap on a flat surface. When the filter plate is fitted correctly or soffit to the soffit, you will see that all the surfaces are level.



# REMOVING THE FILTER CANISTER & CLEANING THE RainWatch FILTER

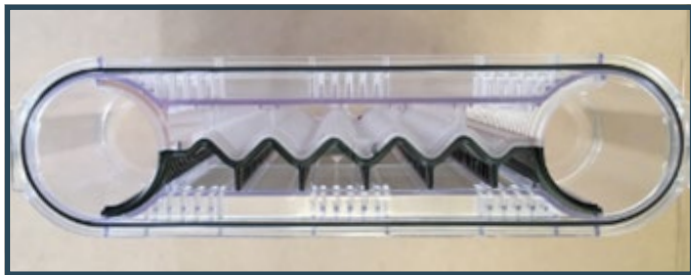

## 5 | CANISTER O-RING

Ensure that the canister's o-ring remain intact as shown.

## 6 | REPLACING CLIPS

Insert a clip either side (as shown) ensuring the canister is accurately fitted and then all other clips can be fitted.

Once all the clips are fitted, the RainWatch filter will fit snugly back into the existing brackets.



## CHECKLIST

- This installation has .....Rainwatch Filters per 100 m<sup>2</sup> of Roof Area.
- This installation is provided with a 150 mm relief overflow above the RainWatch Filter and has a minimum relief of 150 mm from the bottom of the gutter for a continual discharge making sure that no water can enter the as building as detailed.

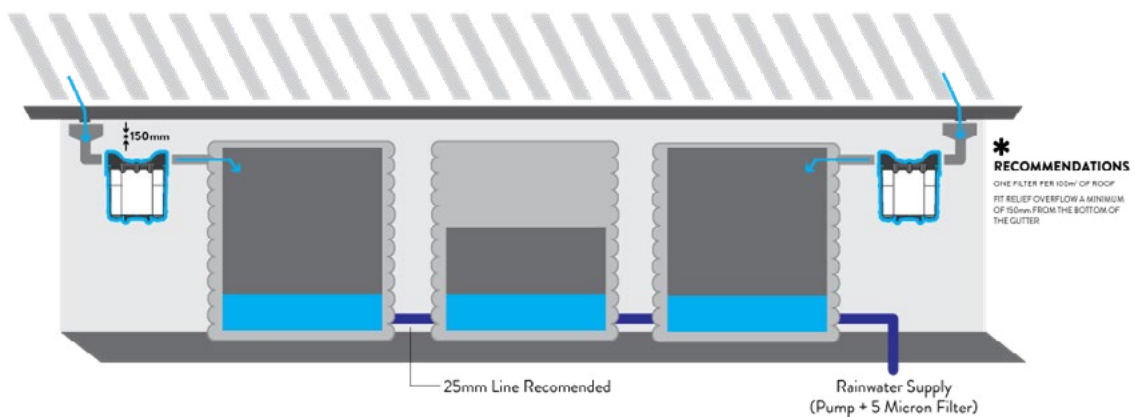

- Date of installation  By